

**PDFN5X6-8L N Channel Enhancement 沟道增强型
MOS Field Effect Transistor 场效应管**

■ Features 特点

Low on-resistance 低导通电阻
 $R_{DS(ON)}=5.5m\Omega(\text{Type})@V_{GS}=10V$
 $R_{DS(ON)}=9.5m\Omega(\text{Type})@V_{GS}=4.5V$

■ Applications 应用

Load Switching 负载开关
 Uninterruptible power supply 不间断电源
 switched and high frequency circuits 开关和高频电路

■ Internal Schematic Diagram 内部结构

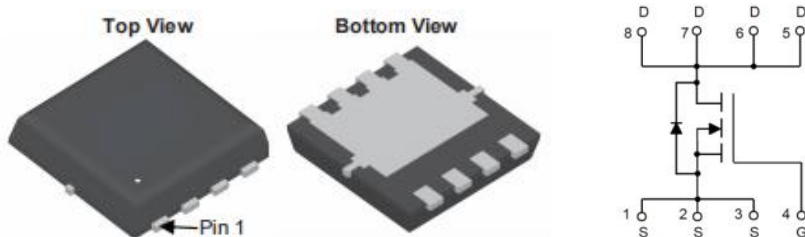

■ Absolute Maximum Ratings 最大额定值

Characteristic 特性参数	Symbol 符号	Rat 额定值	Unit 单位
Drain-Source Voltage 漏极-源极电压	BV_{DSS}	30	V
Gate- Source Voltage 栅极-源极电压	V_{GS}	± 20	V
Drain Current (continuous)漏极电流-连续	I_D (at $T_C = 25^\circ C$ at $T_C = 100^\circ C$)	40 25	A
Drain Current (pulsed)漏极电流-脉冲	I_{DM}	140	A
Total Device Dissipation 总耗散功率	P_{TOT} (at $T_C = 25^\circ C$ at $T_A = 25^\circ C$)	21 5	W
Avalanche Energy(Single Pulse)雪崩能量	E_{AS}	56	mJ
Thermal Resistance Junction-Ambient 热阻	$R_{\theta JC}/R_{\theta JA}$	6/25	$^\circ C/W$
Junction/Storage Temperature 结温/储存温度	T_J, T_{stg}	-55~150	$^\circ C$

■ **Electrical Characteristics 电特性**

($T_A=25^{\circ}\text{C}$ unless otherwise noted 如无特殊说明, 温度为 25°C)

Characteristic 特性参数	Symbol 符号	Min 最小值	Typ 典型值	Max 最大值	Unit 单位
Drain-Source Breakdown Voltage 漏极-源极击穿电压($I_D=250\mu\text{A}, V_{GS}=0\text{V}$)	BV_{DSS}	30	—	—	V
Gate Threshold Voltage 栅极开启电压($I_D=250\mu\text{A}, V_{GS}=V_{DS}$)	$V_{GS(th)}$	1.0	1.5	2.5	V
Zero Gate Voltage Drain Current 零栅压漏极电流($V_{GS}=0\text{V}, V_{DS}=30\text{V}$)	I_{DSS}	—	—	1	μA
Gate Body Leakage 栅极漏电流($V_{GS}=\pm 20\text{V}, V_{DS}=0\text{V}$)	I_{GSS}	—	—	± 100	nA
Static Drain-Source On-State Resistance 静态漏源导通电阻($I_D=15\text{A}, V_{GS}=10\text{V}$) ($I_D=15\text{A}, V_{GS}=4.5\text{V}$)	$R_{DS(ON)}$	—	5.5 9.5	7.5 11.5	$\text{m}\Omega$
Diode Forward Voltage Drop 内附二极管正向压降($I_{SD}=15\text{A}, V_{GS}=0\text{V}$)	V_{SD}	—	0.8	1.2	V
Input Capacitance 输入电容 ($V_{GS}=0\text{V}, V_{DS}=15\text{V}, f=1\text{MHz}$)	C_{ISS}	—	1015	—	pF
Common Source Output Capacitance 共源输出电容($V_{GS}=0\text{V}, V_{DS}=15\text{V}, f=1\text{MHz}$)	C_{OSS}	—	201	—	pF
Reverse Transfer Capacitance 反馈电容 ($V_{GS}=0\text{V}, V_{DS}=15\text{V}, f=1\text{MHz}$)	C_{RSS}	—	164	—	pF
Total Gate Charge 栅极电荷密度 ($V_{DS}=15\text{V}, I_D=15\text{A}, V_{GS}=10\text{V}$)	Q_g	—	23.6	—	nC
Gate Source Charge 栅源电荷密度 ($V_{DS}=15\text{V}, I_D=15\text{A}, V_{GS}=10\text{V}$)	Q_{gs}	—	7	—	nC
Gate Drain Charge 栅漏电荷密度 ($V_{DS}=15\text{V}, I_D=15\text{A}, V_{GS}=10\text{V}$)	Q_{gd}	—	3.9	—	nC
Turn-ON Delay Time 开启延迟时间 ($V_{DS}=20\text{V}, I_D=2\text{A}, R_{GEN}=3\Omega, V_{GS}=10\text{V}$)	$t_{d(on)}$	—	7	—	ns
Turn-ON Rise Time 开启上升时间 ($V_{DS}=20\text{V}, I_D=2\text{A}, R_{GEN}=3\Omega, V_{GS}=10\text{V}$)	t_r	—	19	—	ns
Turn-OFF Delay Time 关断延迟时间 ($V_{DS}=20\text{V}, I_D=2\text{A}, R_{GEN}=3\Omega, V_{GS}=10\text{V}$)	$t_{d(off)}$	—	24	—	ns
Turn-OFF Fall Time 关断下降时间 ($V_{DS}=20\text{V}, I_D=2\text{A}, R_{GEN}=3\Omega, V_{GS}=10\text{V}$)	t_f	—	24	—	ns

■ Typical Characteristic Curve 典型特性曲线

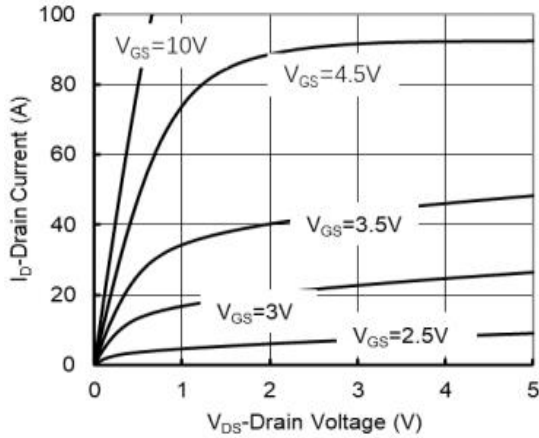

Figure 1: Output Characteristics

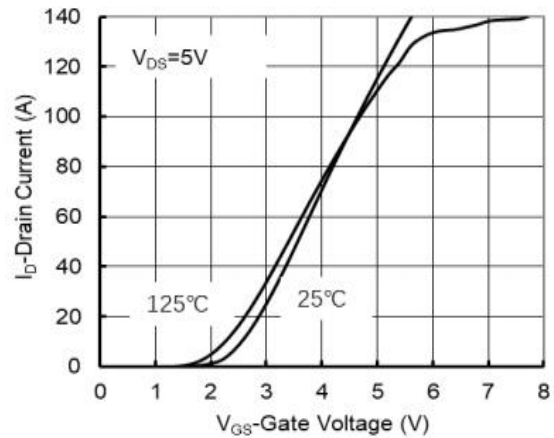

Figure 2: Transfer Characteristics

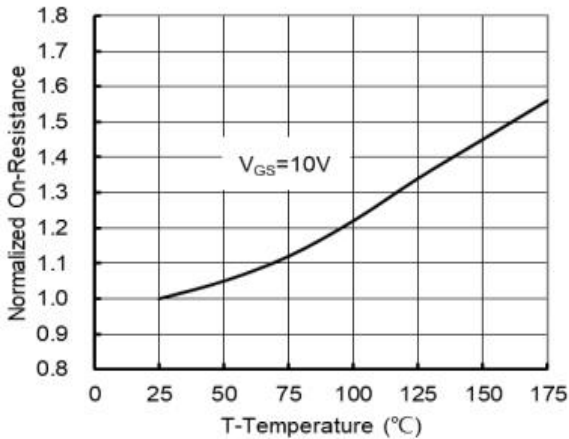

Figure 3: On-Resistance vs. T_j

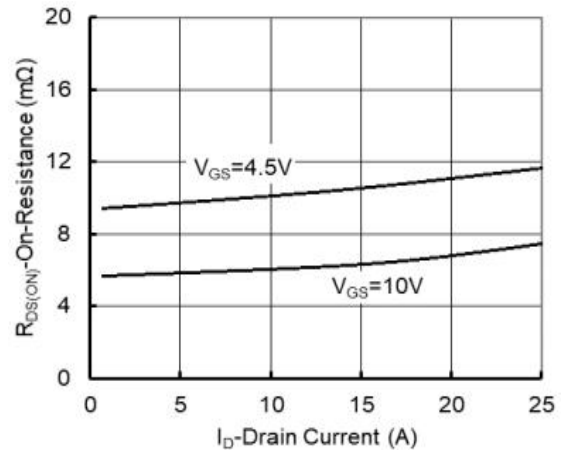

Figure 4: On-Resistance vs. Drain Current

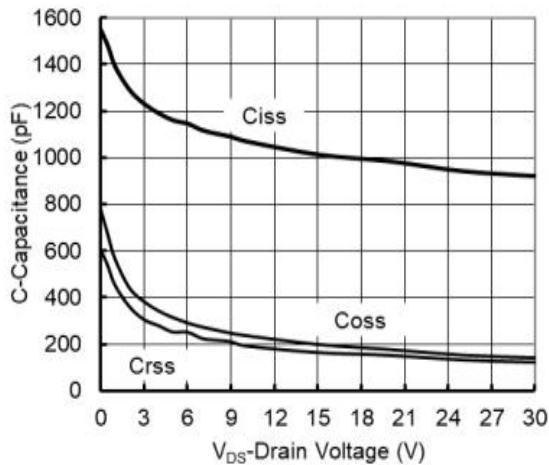

Figure 5: Capacitance Characteristics

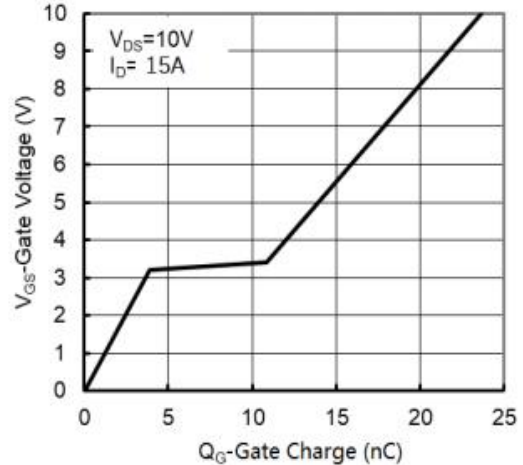

Figure 6: Gate-Charge Characteristics

■ Typical Characteristic Curve 典型特性曲线

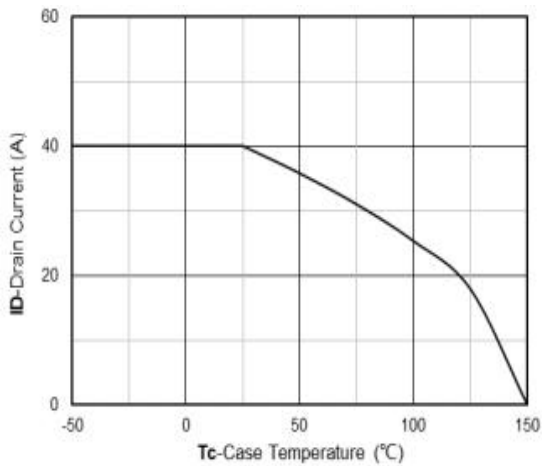

Figure 7: Drain Current Characteristics

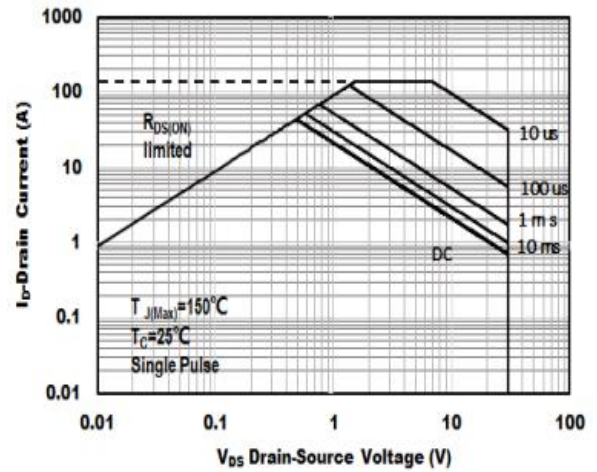

Figure 8: Safe Operating Area

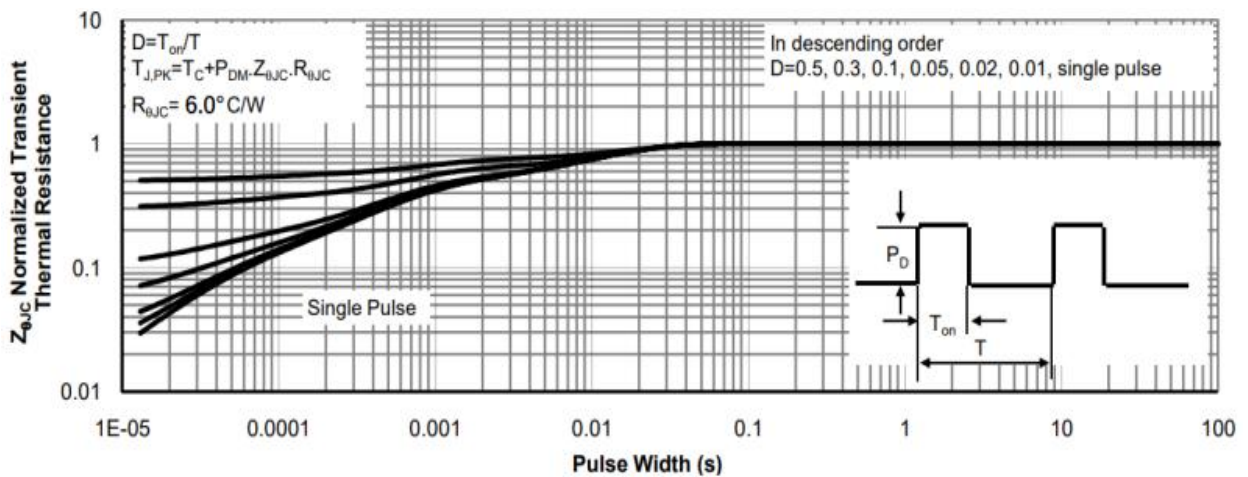
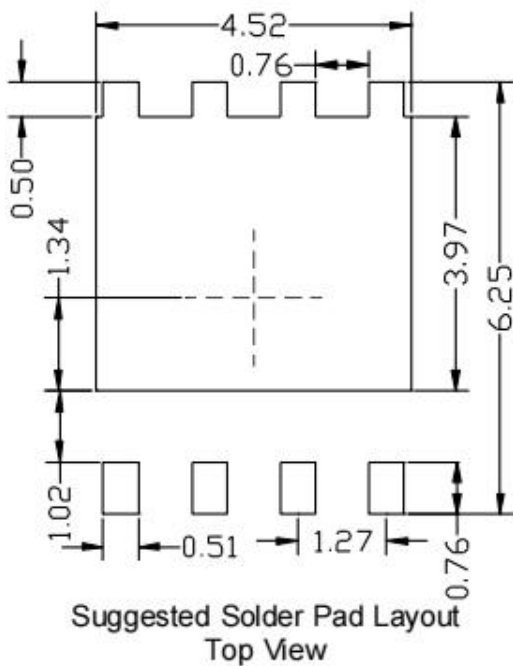
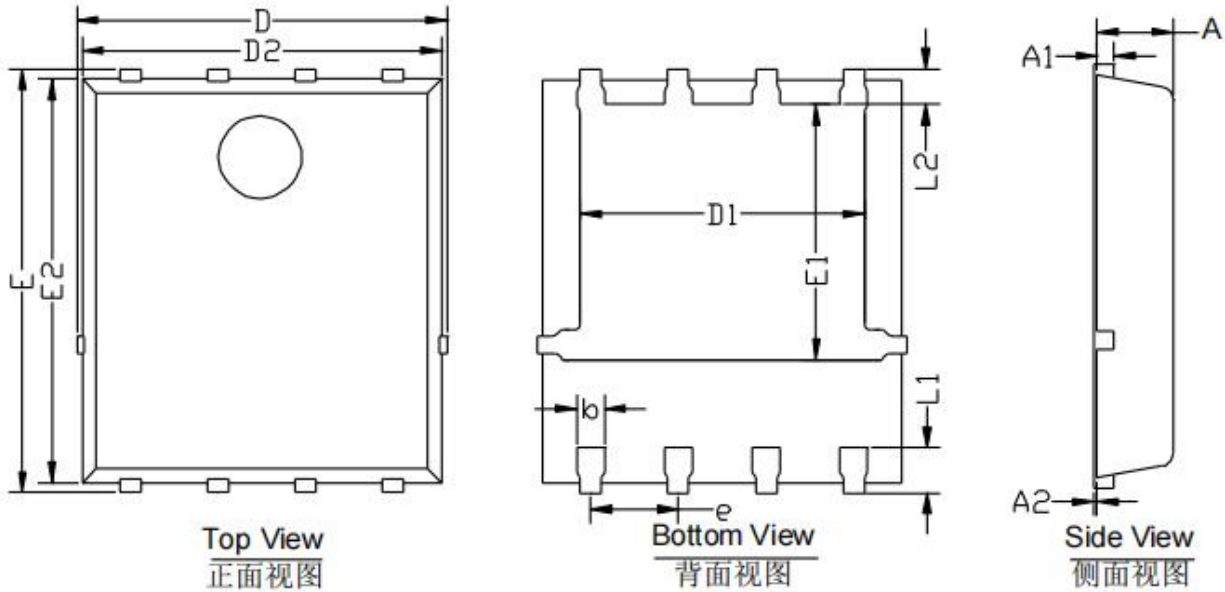

Figure 9: Transient Thermal Response Curve

■ Dimension 外形封装尺寸



SYMBOL	MILLIMETER		
	MIN	NOM	MAX
D	5.15	5.35	5.55
E	5.95	6.15	6.35
A	1.00	1.10	1.20
A1	0.254 BSC		
A2			0.10
D1	3.92	4.12	4.32
E1	3.52	3.72	3.92
D2	5.00	5.20	5.40
E2	5.66	5.86	6.06
L1	0.56	0.66	0.76
L2	0.50 BSC		
b	0.31	0.41	0.51
e	1.27 BSC		